



# Da Vinci SP Instrument and Accessory Catalogue Europe

October 2025

For more information, call Intuitive.

+800 0821 2020 (toll-free) / +41 21 821 2020 or visit [www.intuitive.com](http://www.intuitive.com)

For the name of your local distributor, call Intuitive or visit [www.intuitive.com](http://www.intuitive.com).

Some products, features or technologies may not be available in all countries. Please contact your local Intuitive representative for product availability in your region. Refer to the product specific User Manual for indications, contraindications, warnings and other product information.

## Table of contents

### **6 mm instruments**

- 4 Monopolar cautery instruments
- 5 Bipolar cautery instruments
- 6 Instruments

### **Accessories**

- 7 Reusable accessories
- 7 Disposable accessories

### **Vision equipment**

- 8 Endoscope
- 8 Handheld camera

### **Training equipment**

- 8 Training instruments

### **Cleaning and sterilization**

- 9 Cleaning and sterilization

### **Documentation**

- 9 Documentation

### **Specifications**



- 10 Instrument specifications
- 11 Common carton dimensions and weights

### **Contact information**

- 12 Technical support and customer service

6 mm  
instruments

Monopolar cautery instruments

	Product description	Part number
	<b>Monopolar curved scissors</b> 25 uses	<b>430100</b>
	<b>Monopolar curved scissors extended range</b> 25 uses	<b>431100</b>
	Shown with <b>monopolar curved scissors tip</b> <b>(sold separately - 1 procedure)<sup>1</sup></b>	<b>430035</b>
	<b>Monopolar cautery instrument</b> 25 uses	<b>430101</b>
	Shown with <b>cautery hook tip</b> <b>(sold separately - 1 procedure)<sup>1</sup></b>	<b>400156</b>
	<b>Monopolar cautery instrument</b> 25 uses	<b>430101</b>
	Shown with <b>cautery spatula tip</b> <b>(sold separately - 1 procedure)<sup>1</sup></b>	<b>400160</b>

<sup>1</sup> The cautery spatula tip, cautery hook tip, and monopolar curved scissors tip can be ordered separately. Cautery hook tip (box of 10) part number 400156. Cautery spatula tip (box of 10) part number 400160. Monopolar curved scissors tip (box of 10) part number 430035.



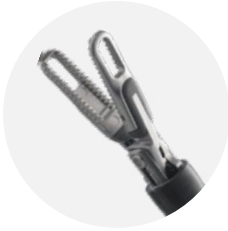
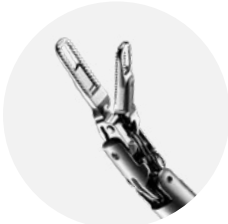

6 mm  
instruments

Bipolar cautery instruments

	Product description	Part number
	<b>Maryland bipolar forceps</b> 25 uses	<b>430152</b>
	<b>Maryland bipolar forceps extended range</b> 25 uses	<b>431152</b>
	<b>Fenestrated bipolar forceps</b> 25 uses	<b>430151</b>
	<b>Force bipolar extended range</b> 20 uses	<b>431150</b>

6 mm  
instruments

Instruments

	Product description	Part number
	<b>Needle driver</b> 25 uses	<b>430200</b>
	<b>Needle driver extended range</b> 25 uses	<b>431200</b>
	<b>Cadiere forceps</b> 25 uses	<b>430300</b>
	<b>Cadiere forceps extended range</b> 25 uses	<b>431300</b>
	<b>Round tooth retractor extended range</b> 25 uses	<b>431301</b>
	<b>Medium-large clip applicator<sup>1</sup></b> 150 uses <small>(Shown with Weck® Hem-o-lok® polymer ligating clips medium-large.)</small> Validated for use only with Weck® Hem-o-lok® polymer ligating clips medium-large.	<b>430250</b>
	<b>Weck product code:</b>	544230









<sup>1</sup> Weck® Hem-o-lok® polymer ligating clips medium-large (Weck product code 544230) are the only compatible clips used with this instrument. To order, contact Teleflex Medical ([www.teleflex.com](http://www.teleflex.com)) or your local distributor.

## Accessories

## Reusable accessories

	Product description	Qty/ box	Uses	Part number
	Cannula, 25 mm x 100 mm	1	NA	<b>430036</b>
	Obturator, 25 mm x 100 mm	1	NA	<b>430016</b>
	Bipolar cautery cord	1	20	<b>470384</b>
	EnergyShield monopolar cautery cord	1	NA	<b>430068</b>

## Disposable accessories





	Product description	Qty/ box	Uses	Part number
	Monopolar curved scissors tip (box of 10)	10	1 procedure	<b>430035</b>
	Cautery hook tip (box of 10)	10	1 procedure	<b>400156</b>
	Cautery spatula tip (box of 10)	10	1 procedure	<b>400160</b>
	Instrument sheath (box of 30)	30	1 procedure	<b>430012</b>
	Camera sheath (box of 10)	10	1 procedure	<b>430020</b>
	Instrument arm drape	1	1 procedure	<b>430013</b>
	Access port kit, small incision (2.7 cm to 4 cm incision size (box of 6) includes: • Access port • Short entry guide • Wound protector	6	1 procedure	<b>430073</b>
	Access port kit, large incision (2.7 cm to 7 cm incision size (box of 6) includes: • Access port • Short entry guide • Wound protector	6	1 procedure	<b>430075</b>
	Entry guide kit (box of 6) includes: • Entry guide cannula insert • Entry guide cannula seal	6	1 procedure	<b>430022</b>

Vision  
equipment

## SP endoscope

	Product description	Qty/ box	Uses	Part number
	SP endoscope, 0°	1	33	<b>430077</b>

## Handheld camera components

	Product description	Qty/ box	Uses	Part number
	Handheld camera	1	NA	<b>470035</b>
	Handheld camera light guide cable	1	NA	<b>470042</b>
	Handheld camera light guide adapter	1	NA	<b>470051</b>
	Handheld camera stainless steel reprocessing tray	1	NA	<b>400499</b>

Training  
equipment





## Training instruments

Product description	Qty/ box	Uses	Part number
Monopolar Curved Scissors	1	75	<b>430100-T</b>
Monopolar Curved Scissors Extended Range	1	75	<b>431100-T</b>
Monopolar Cautery Instrument	1	75	<b>430101-T</b>
Force Bipolar Extended Range	1	64	<b>431150-T</b>
Fenestrated Bipolar Forceps	1	75	<b>430151-T</b>
Maryland Bipolar Forceps	1	75	<b>430152-T</b>
Maryland Bipolar Forceps Extended Range	1	75	<b>431152-T</b>
Needle Driver	1	75	<b>430200-T</b>
Needle Driver Extended Range	1	75	<b>431200-T</b>
Medium-large clip applier <sup>1</sup>	1	450 closures	<b>430250-T</b>
Cadiere Forceps	1	75	<b>430300-T</b>
Cadiere Forceps Extended Range	1	75	<b>431300-T</b>
Round Tooth Retractor Extended Range	1	75	<b>431301-T</b>
SP endoscope, 0°	1	64	<b>430077-T</b>

<sup>1</sup> Weck® Hem-o-lok® polymer ligating clips medium-large (Weck product code 544230) are the only compatible clips used with this instrument. To order, contact Teleflex Medical ([www.teleflex.com](http://www.teleflex.com)) or your local distributor.

## Cleaning and sterilization

### Cleaning and sterilization

	Product description	Qty/ box	Uses	Part number
	SP instrument reprocessing tray	1	NA	<b>430850</b>
	SP endoscope reprocessing tray	1	NA	<b>430851</b>
	SP reprocessing connector (1 device)	1	NA	<b>430852</b>
	SP reprocessing connector (2 devices)	1	NA	<b>430853</b>
	Cleaning and sterilization kit includes: <ul style="list-style-type: none"> <li>• Flush port adaptor</li> <li>• Brush with nylon bristles</li> <li>• Pipe-to-hose adapter</li> <li>• Leak test adapter</li> </ul>	1	NA	<b>430048</b>

## Documentation

### Documentation<sup>1</sup>

Product description	Part number
Reprocessing documentation kit <ul style="list-style-type: none"> <li>• Reprocessing instructions for instruments, accessories and endoscope</li> </ul>	<b>400281</b>
System user manual	<b>554432</b>
Instrument and accessory user manual	<b>554438</b>
Wall chart kit	<b>381476</b>

<sup>1</sup> Documentation is listed in English only. For other languages contact Intuitive customer service. Documentation may not be available in all languages.

Note: Content and part numbers of the kits may vary. More documentation is available on demand and in PDF format. For details contact Intuitive customer service.

## Instrument specifications

Part number	Uses	Product description	Grip open length (mm)	Grip length (mm)	Maximum elbow articulation	Maximum working length (cm)	Maximum instrument length (cm)
430100	25	Monopolar Curved Scissors	3.5 mm	12.8 mm	39 mm	32 cm (12.6")	64.5 cm (25.4")
431100	25	Monopolar Curved Scissors Extended Range	3.5 mm	12.8 mm	51 mm	32 cm (12.6")	64.5 cm (25.4")
430101	25	Monopolar Cautery Instrument	N/A	N/A	39 mm	32 cm (12.6")	64.5 cm (25.4")
431150	20	Force Bipolar Extended Range	11.3 mm	20.3 mm	51 mm	32 cm (12.6")	64.5 cm (25.4")
430151	25	Fenestrated Bipolar Forceps	11.3 mm	20.3 mm	39 mm	32 cm (12.6")	64.5 cm (25.4")
430152	25	Maryland Bipolar Forceps	10.4 mm	18.1 mm	39 mm	32 cm (12.6")	64.5 cm (25.4")
431152	25	Maryland Bipolar Forceps Extended Range	10.4 mm	18.1 mm	51 mm	32 cm (12.6")	64.5 cm (25.4")
430200	25	Needle Driver	4 mm	9.8 mm	39 mm	32 cm (12.6")	64.5 cm (25.4")
431200	25	Needle Driver Extended Range	4 mm	9.8 mm	51 mm	32 cm (12.6")	64.5 cm (25.4")
430250	25	Medium Large Clip Applier	6 mm	14.5 mm	39 mm	32 cm (12.6")	64.5 cm (25.4")
430300	25	Cadiere Forceps	11.7 mm	17.7 mm	39 mm	32 cm (12.6")	64.5 cm (25.4")
431300	25	Cadiere Forceps Extended Range	11.7 mm	17.7 mm	51 mm	32 cm (12.6")	64.5 cm (25.4")
431301	25	Round Tooth Retractor Extended Range	10.5 mm	20.3 mm	51 mm	32 cm (12.6")	64.5 cm (25.4")

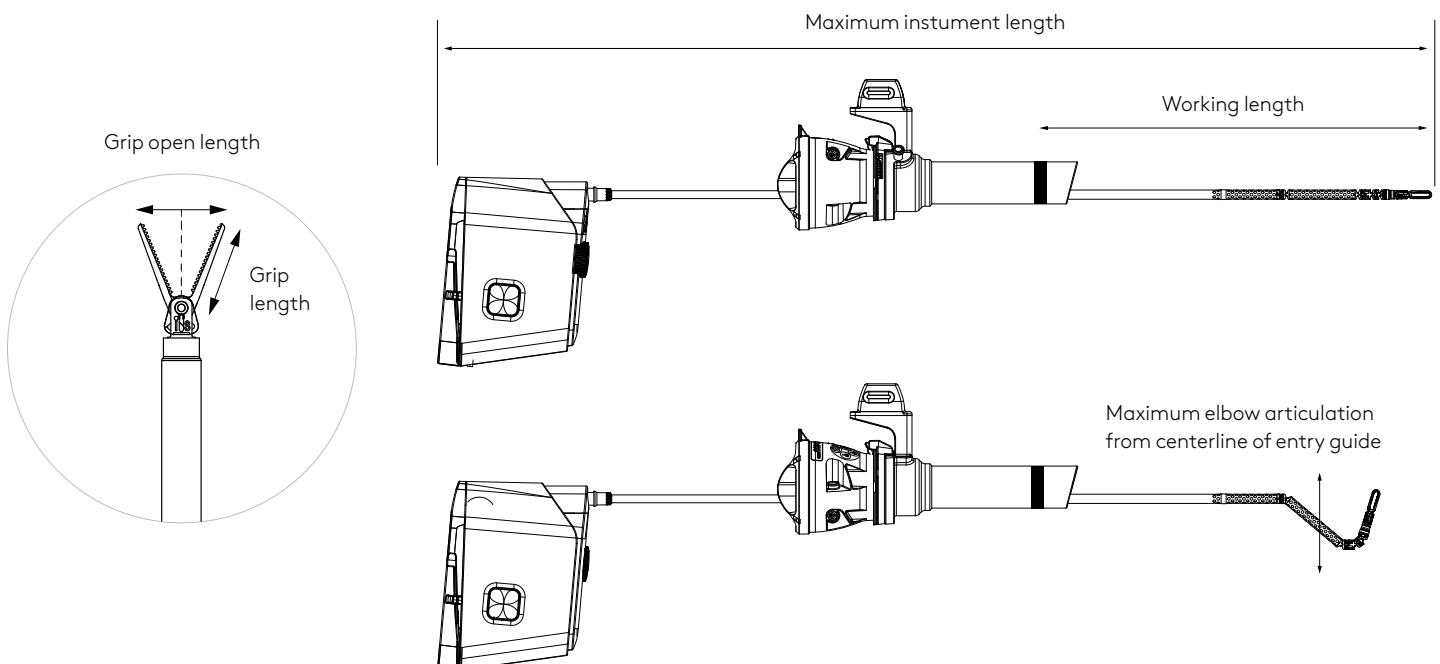

## Common carton dimensions and weights

Item	Item code	Outside dimensions	Average weight
Instruments	Most	73.66 x 6.83 x 18.10 cm 29" x 2.69" x 7.13"	0.54 kg 1.18 lbs
Monopolar curved scissors tip	430035	28.8925 x 11.43 x 8.59 cm 11.375" x 4.50" x 3.38"	0.34 kg 0.75 lbs
Access port kit (small and large incision)	430073 430075	24.1 x 11.7 x 43.9 cm 9.5" x 4.6" x 17.3"	0.9 kg 1.9 lbs
Entry guide kit	430022	25.55 x 13.18 x 7.14 cm 10.063" x 5.188" x 2.81"	2.05 kg 4.52 lbs
Sheaths	430020	65.10 x 8.26 x 13.34 cm 25.63" x 3.25" x 5.25"	0.61 kg 1.34 lbs
	430012		0.72 kg 1.58 lbs
Cannula, 25 mm x 100 mm	430036	36.35 x 13.97 x 12.34 cm 14.31" x 5.50" x 4.86"	0.48 kg 1.06 lbs
Obturator, 25 mm x 100 mm	430016	36.35 x 13.97 x 12.34 cm 14.31" x 5.50" x 4.86"	0.47 kg 1.04 lbs
Shielded monopolar cord	430068	24.77 x 16.19 x 3.49 cm 9.75" x 6.38" x 1.38"	0.28 kg 0.62 lbs
Bipolar cautery cord	470384	24.77 x 16.19 x 3.49 cm 9.75" x 6.38" x 1.38"	0.26 kg 0.57 lbs
Drape	430013	39.70 x 38.58 x 18.64 cm 15.63" x 15.19" x 7.34"	2.95 kg 6.50 lbs
SP endoscope	430077	81.6102 x 29.21 x 9.3726 cm 32.13" x 11.5" x 3.69"	2.27 kg 5.00 lbs

## Technical Support and Customer Service

### Contact us by phone

+800 0821 2020 (international toll-free) or use a local/local toll-free number:

**Austria**  
0126 752 25  
0800 298 890

**Finland**  
0800 415 729  
0800 416 321

**Ireland**  
019 131 227  
1800 851 011

**Switzerland**  
021 821 2020  
0800 821 200

**Belgium**  
02 888 17 49  
0800 716 96

**France**  
05 37 10 02 26  
0800 905 720

**Norway**  
21 98 41 47

**The Netherlands**  
020 8081 348  
0800 0249 547

**Denmark**  
89 872 907  
808 31158

**Germany**  
0761 488 8962  
0800 1825 068

**Sweden**  
08 580 987 81  
020 127 661

**United Kingdom**  
01865 521 820  
0800 066 8902

### The options during your call

#### Option 1: Emergency Technical Support

Support in local language:

Business days,  
Mo. – Fr. 07:00 – 17:00 CET

Support in English: 365/24/7

#### Option 2: Non-urgent Technical Question

Business days,  
Mo. – Fr. 07:00 – 17:00 CET

#### Option 3: Customer Service

- Purchase order inquiries
- Complaint
- Product return authorization
- Product exchanges

Business days,  
Mo. – Fr. 08:00 – 18:00 CET

You can access services also 24/7  
on the Intuitive Customer Portal.

For more information please visit:  
[my.intuitive.com](http://my.intuitive.com)

#### Option 4: Digital Products Support

- User account management
- Login and password issues
- Troubleshooting etc.

Business days,  
Mo. – Fr. 08:00 – 18:00 CET

### Contact us by e-mail

**Austria:**  
[Support.AT@intusurg.com](mailto:Support.AT@intusurg.com)

**Belgium:**  
[Support.BE@intusurg.com](mailto:Support.BE@intusurg.com)

**Denmark:**  
[Support.DK@intusurg.com](mailto:Support.DK@intusurg.com)

**Finland:**  
[Support.FI@intusurg.com](mailto:Support.FI@intusurg.com)

**France:**  
[Support.FR@intusurg.com](mailto:Support.FR@intusurg.com)

**Germany:**  
[Support.DE@intusurg.com](mailto:Support.DE@intusurg.com)

**Ireland:**  
[Support.IE@intusurg.com](mailto:Support.IE@intusurg.com)

**Luxembourg:**  
[Support.LU@intusurg.com](mailto:Support.LU@intusurg.com)

**Norway:**  
[Support.NO@intusurg.com](mailto:Support.NO@intusurg.com)

**Sweden:**  
[Support.SE@intusurg.com](mailto:Support.SE@intusurg.com)

**Switzerland:**  
[Support.CH@intusurg.com](mailto:Support.CH@intusurg.com)

**The Netherlands:**  
[Support.NL@intusurg.com](mailto:Support.NL@intusurg.com)

**United Kingdom:**  
[Support.UK@intusurg.com](mailto:Support.UK@intusurg.com)

**Digital Products Support:**  
[EU.DigitalSupport@intusurg.com](mailto:EU.DigitalSupport@intusurg.com)

For more information, call Intuitive.

+800 0821 2020 (toll-free) / +41 21 821 2020  
or visit [www.intuitive.com](http://www.intuitive.com)

For the name of your local distributor,  
call Intuitive or visit [www.intuitive.com](http://www.intuitive.com).

Individuals' outcomes may depend on a number  
of factors, including but not limited to patient  
characteristics, disease characteristics and/or  
physician/surgeon experience.

Some products, features or technologies may  
not be available in all countries. Please contact

your local Intuitive representative for product  
availability in your region. Refer to the product  
specific User Manual for indications, con-  
traindications, warnings and other product  
information.

Intuitive's Privacy Notice is available at  
[www.intuitive.com/privacy](http://www.intuitive.com/privacy).

© 2025 Intuitive Surgical Operations, Inc.  
All rights reserved. Product and brand names/  
logos, including Intuitive, da Vinci, and Ion,  
are trademarks or registered trademarks of  
Intuitive Surgical or their respective owner.